



## BRIEF INFORMATION

### COMET FF 450 / FF 500 / FF 550

- Light technology in new design and various designs
- Available as high beam and fog lights
- Ideal for offroaders, pick-up drivers and SUV cruisers

## PRODUCT FEATURES

The COMET FF auxiliary driving lights unite modern design, convincing light performance and proven HELLA quality. As high-beam headlights they are the ideal supplement to the standard high-beam light and ensure as fog lights improved vision in case of fog, rain or snowfall. Three different models in modern design – optionally: rectangular, round or oval – integrate harmoniously into vehicle front-ends.

- Comprehensive, non-patterned brilliant clear-glass lens
- New free-form reflectors with computer-calculated light distribution for powerful light performance
- Sturdy plastic housing
- Reflector tightly adhered to the glass lens
- Shallow installation depth for problem-free fitting
- Dimensions correspond to the previous series COMET 450, 500, 550. Hence, the COMET FF 450/ FF 500/ FF 550 are fully compatible for interchanging with the predecessors (same attachment and fitting options as the previous series)
- ECE type-approved

## RANGE OVERVIEW



### Comet FF 450 - rectangular and distinctive

H3 high beam and fog lights  
with black plastic housing for upright and pendant installation  
Weight: 520 g

High-beam light (Ref. 12.5)	<b>1FB 010 951-011</b>
-----------------------------	------------------------

Fog light B3*	<b>1NB 010 951-101</b>
---------------	------------------------



### COMET FF 500 - classic and round

H3 high beam and fog lights  
with black plastic housing for upright installation  
Weight: 700 g

High-beam light (Ref. 17.5)	<b>1F6 010 952-011</b>
-----------------------------	------------------------

Fog light B3*	<b>1N6 010 952-101</b>
---------------	------------------------



### COMET FF 550 - modern and elegant

H3 high beam and fog lights  
with black plastic housing for upright and pendant installation  
Weight: 580 g

High-beam light (Ref. 12.5)	<b>1FD 010 953-011</b>
-----------------------------	------------------------

Fog light B3*	<b>1ND 010 953-101</b>
---------------	------------------------

\* Fog lamps type-approved acc. to ECE R19 class B3



**Dimensions**

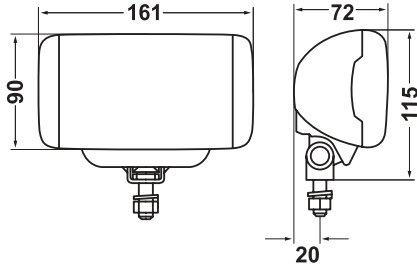

**COMET FF 450**

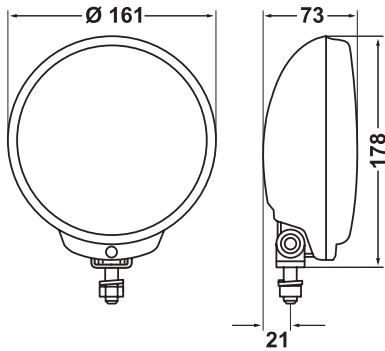

**COMET FF 500**

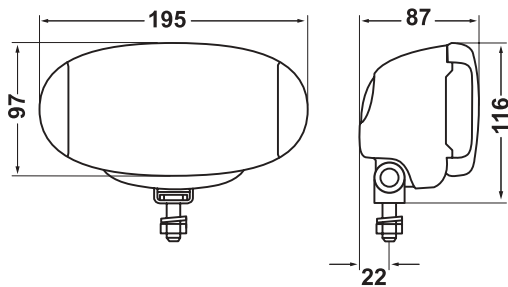

**COMET FF 550**

Part no.	Spotlights	Fog lights	Individual packaging	Set packaging	incl bulb(s) (12 V/55 W)	incl. protective cap(s)*
<b>COMET FF 450</b>						
1FB 010 951-821	●			●	●	●
1FB 010 951-011	●		●		●	●
1FB 010 951-001	●		●			
1NB 010 951-831		●		●	●	●
1NB 010 951-111		●	●		●	●
1NB 010 951-101		●	●			
<b>COMET FF 500</b>						
1F6 010 952-821	●			●	●	●
1F6 010 952-011	●		●		●	●
1F6 010 952-001	●		●			
1F6 010 952-801	●			●	●	
1N6 010 952-811		●		●	●	
1N6 010 952-111		●	●		●	●
1N6 010 952-101		●	●			
<b>COMET FF 550</b>						
1FD 010 953-801	●			●	●	●
1FD 010 953-011	●		●		●	●
1FD 010 953-001	●		●			
1ND 010 953-811		●		●	●	●
1ND 010 953-111		●	●		●	●
1ND 010 953-101		●	●			

\* CAUTION: Protective caps are not legally authorised in some countries. Please inquire accordingly through the relevant authority before use on public roads. In Germany, headlights always have to be ready for operation on public roads in accordance with the FMVSS. Violation of this regulation is an offence.



## SCOPE OF DELIVERY

### Single headlight – without bulb

- 1 COMET FF Single headlight
- Fixing parts
- Installation instructions







### Single headlight – without bulb

- 1 COMET FF Single headlight
- 1 bulb for (H3 12 V/55 W)
- 1 protective cap\*
- Fixing parts
- Installation instructions

### Headlight set – with bulbs

- 2 COMET FF headlights
- 2 bulbs (H3 12 V/55 W)
- several models with 2 protective caps\* (see table on page 3)
- additionally with relay, switch, cable and connection parts
- Fixing parts
- Mounting instructions

\* CAUTION: Protective caps are not legally authorised in some countries. Please inquire accordingly through the relevant authority before use on public roads. In Germany, headlights always have to be ready for operation on public roads in accordance with the FMVSS. Violation of this regulation is an offence.

Version	Comet FF 450			Comet FF 500			Comet FF 550		
High beam	12,5	 HR 01 3221		17,5	 HR 01 3222		12,5	 HR 01 3223	
Fog light		03 B  3221			03 B  3222			03 B  3223	